

MAX0200 MAX120

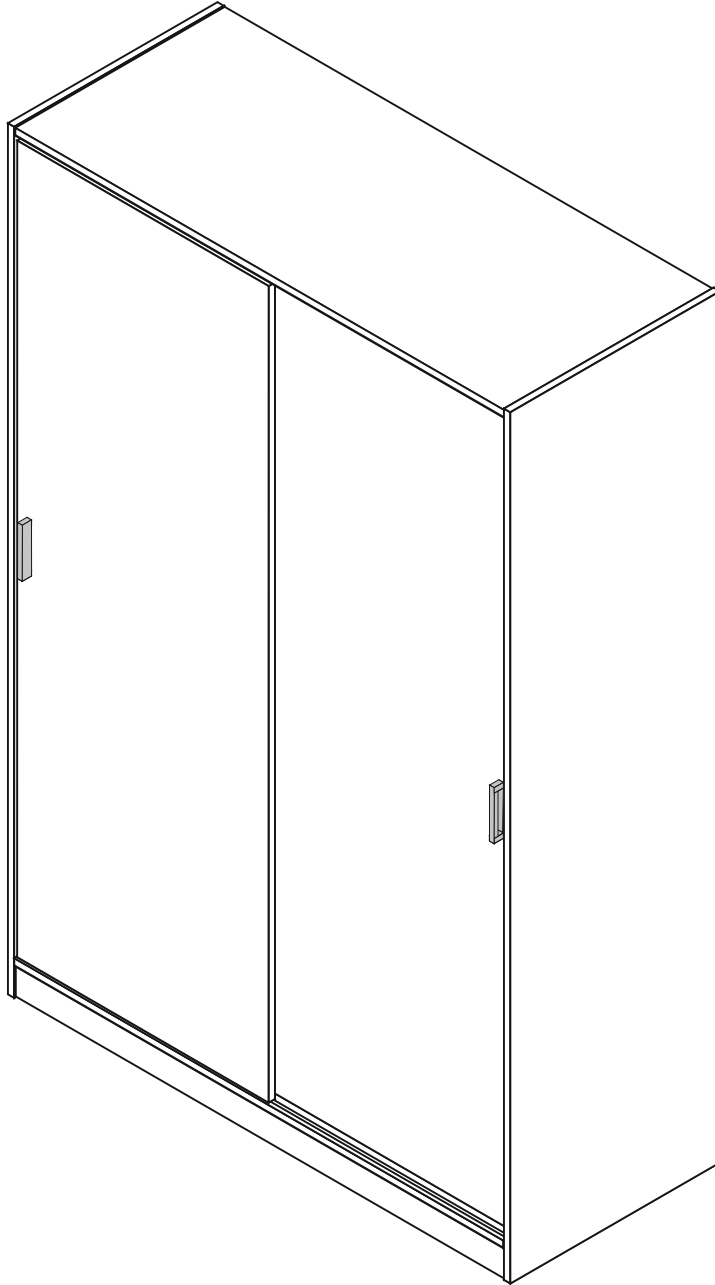

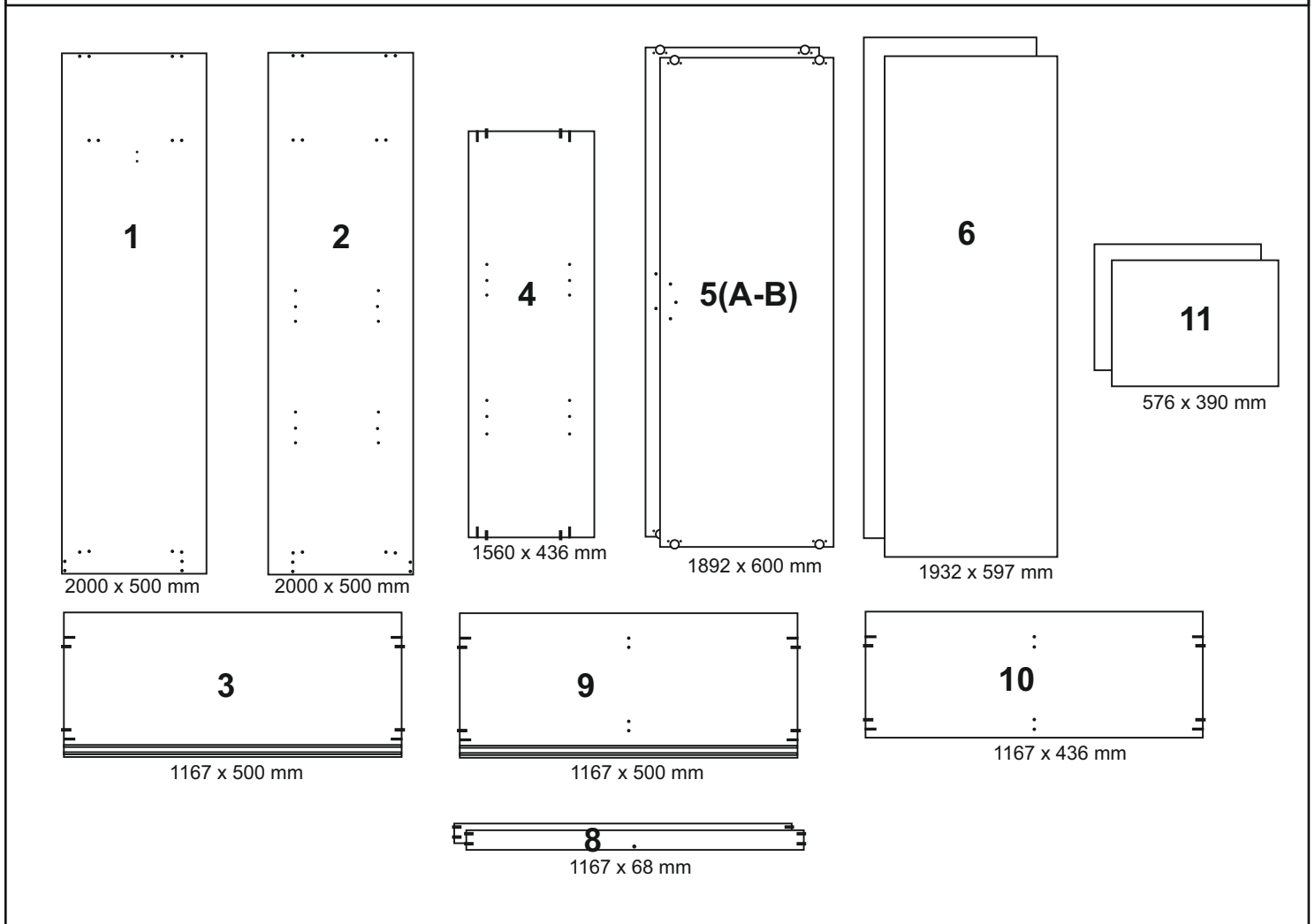

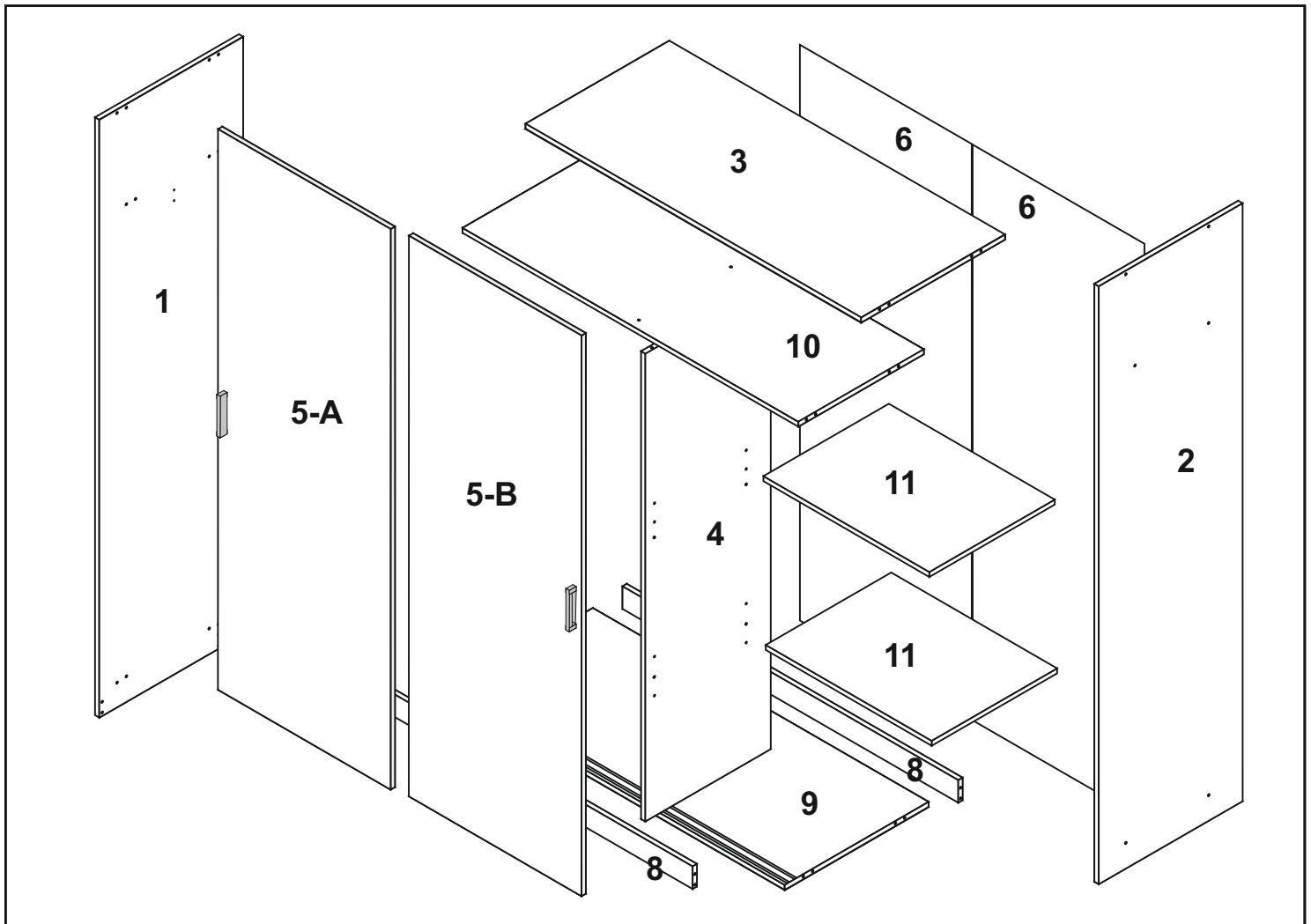



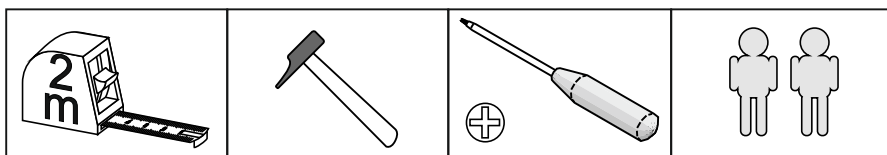

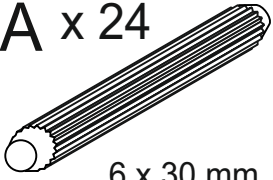

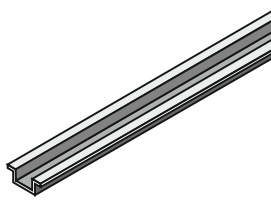
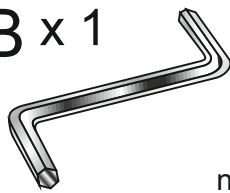
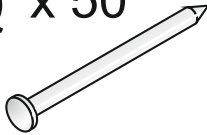
ARMARIO - WARDROBE - ARMOIRE - ROUPEIRO -
GUARDAROBA - KLEIDERSCHRANK - ORMAR - ΝΤΟΥΛΑΠΑ

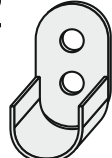
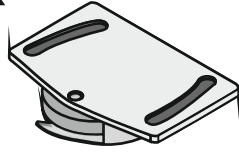
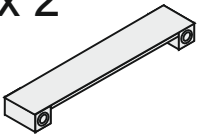
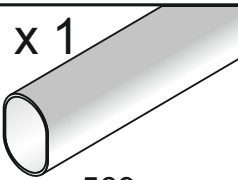
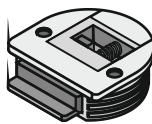
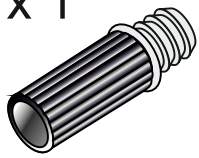
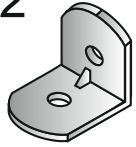
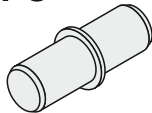
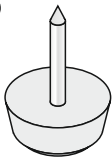
INSTRUCCIONES DE MONTAJE - ASSEMBLING INSTRUCTIONS - NOTICE DE MONTAGE - INSTRUÇÕES DE MONTAGEM -
ISTRUZIONI DI MONTAGGIO - MONTAGEANLEITUNG - UPUTE ZA MONTAŽU - ΟΔΗΓΙΕΣ ΣΥΝΑΡΜΟΛΟΓΗΣΗΣ



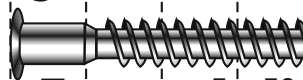
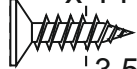

<p>A x 24</p>  <p>6 x 30 mm</p>	<p>P x 12</p>  <p>3 mm</p>	<p>W x 4</p>  <p>1166 mm</p>
<p>B x 1</p>  <p>n° 3</p>	<p>Q x 50</p>  <p>20 mm</p>	
<p>D x 6</p> 	<p>R x 2</p> 	<p>X x 4</p> 
<p>G x 2</p> 	<p>S x 1</p>  <p>569 mm.</p>	<p>Z x 4</p> 
<p>H x 1</p> 		
<p>L x 2</p> 		
<p>M x 8</p>  <p>5 mm.</p>		
<p>N x 6</p> 		

	0	1 cm.	2	3	4	5
	C x 16					
						
	F x 14					
						
	3,5 x 16 mm					
	U x 8					
						
	3 x 15 mm					
	Y x 4					
						
	3,5 x 27 mm					

1

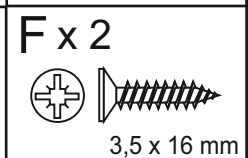
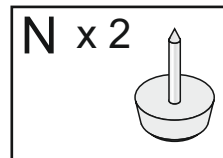
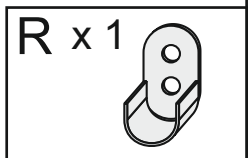
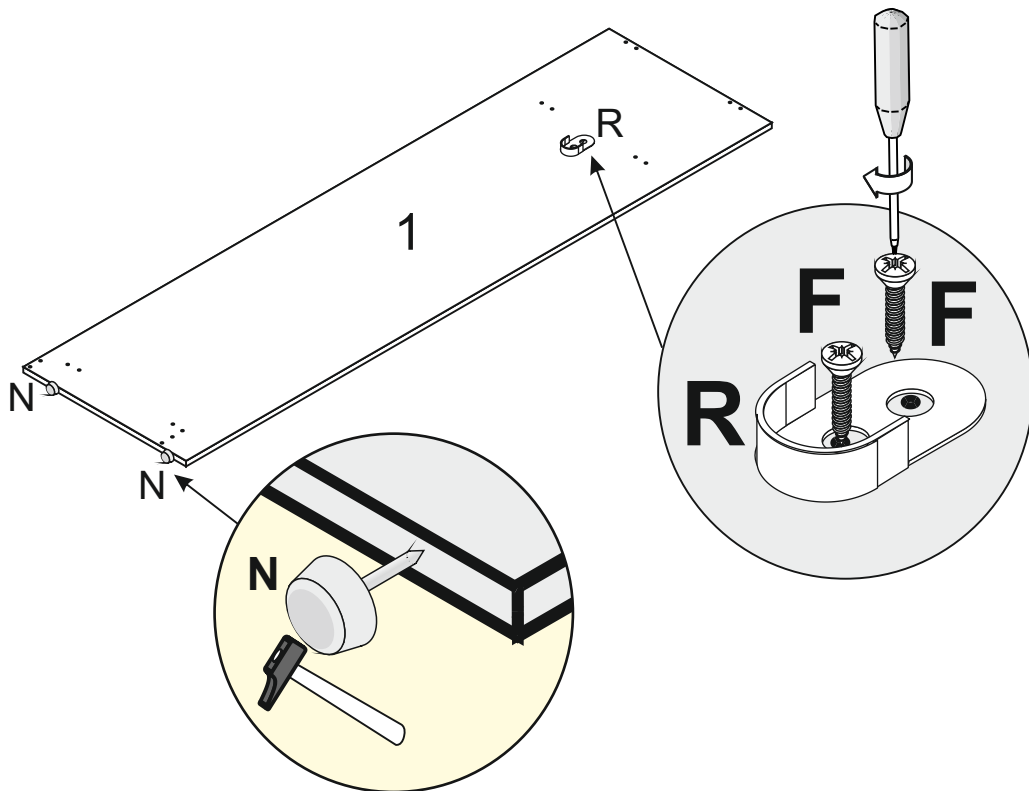

2

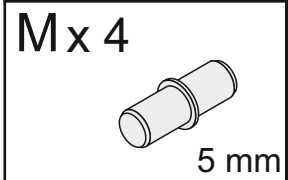
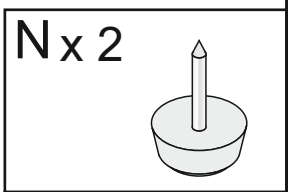
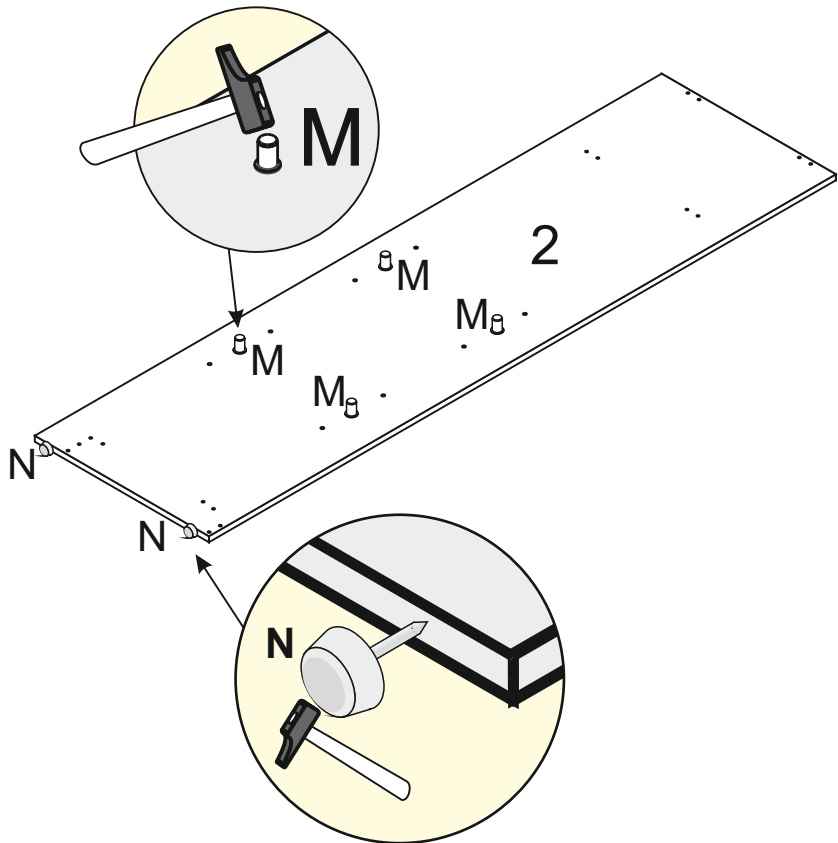

3

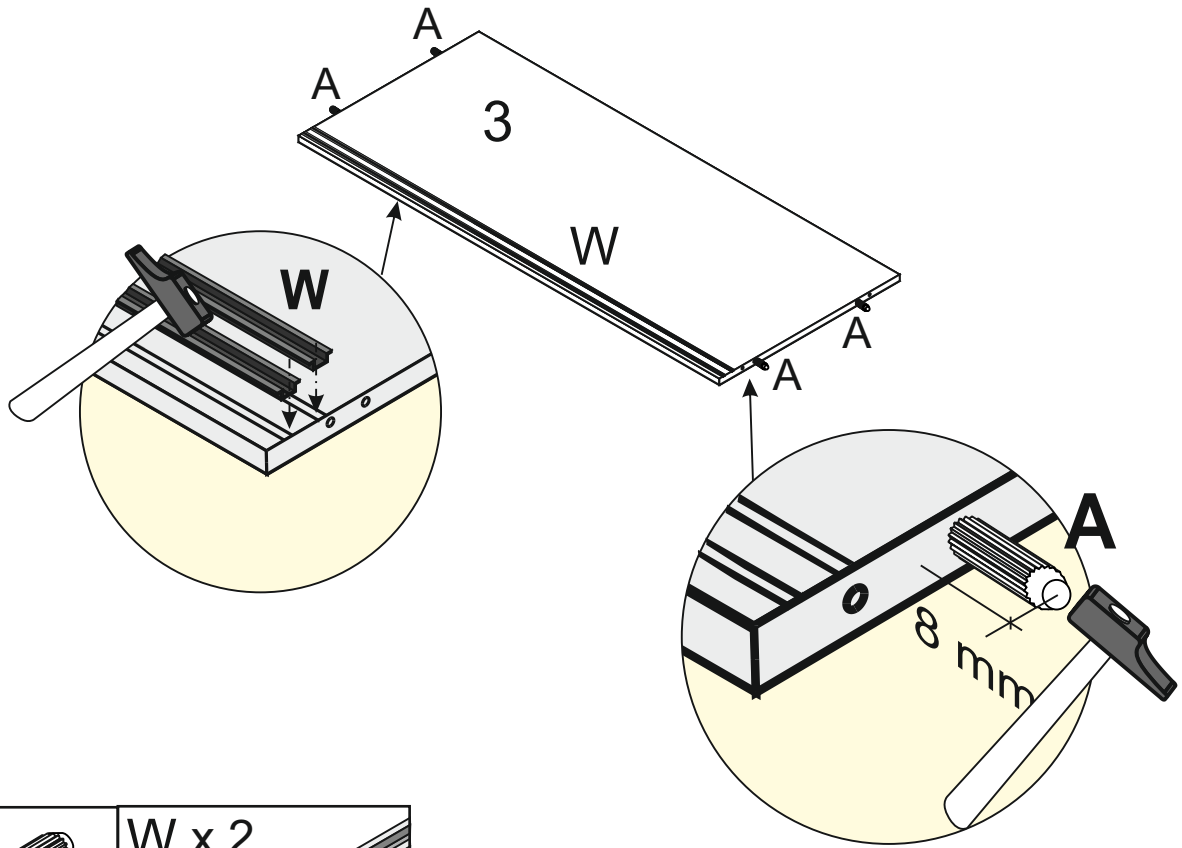

A x 4

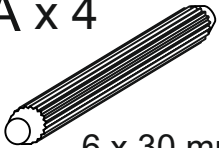

6 x 30 mm

W x 2

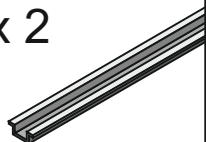

1166 mm

4

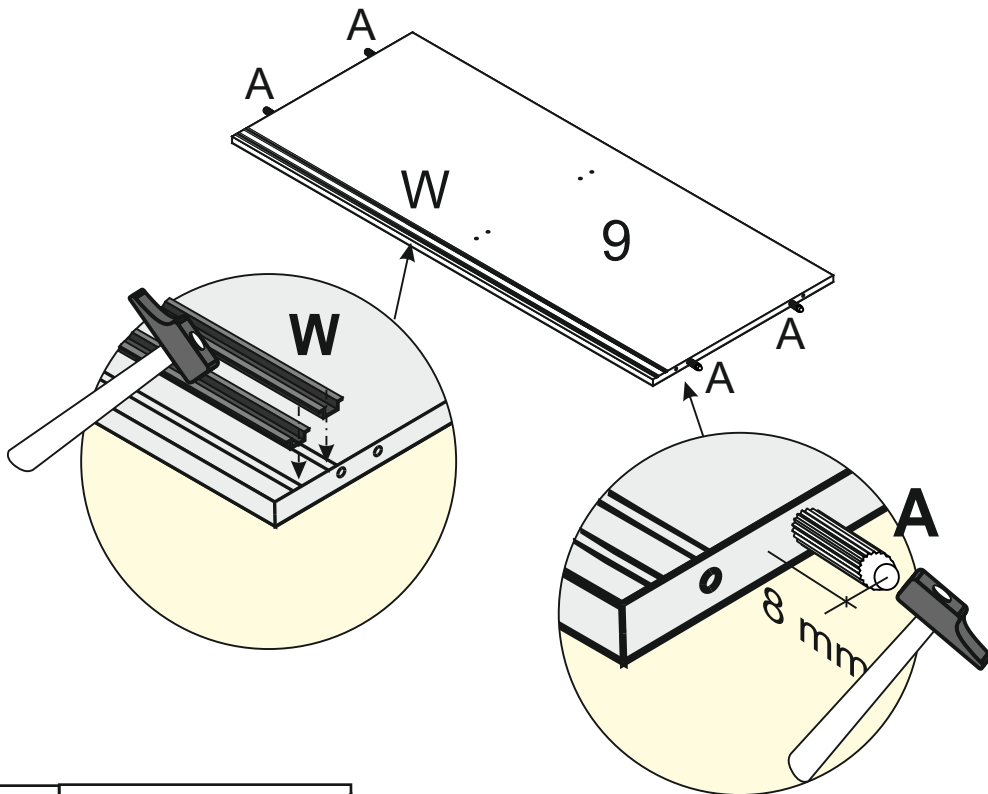

A x 4

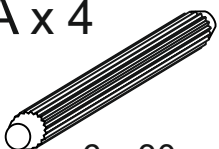

6 x 30 mm

W x 2

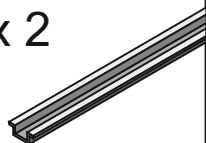

1166 mm

5

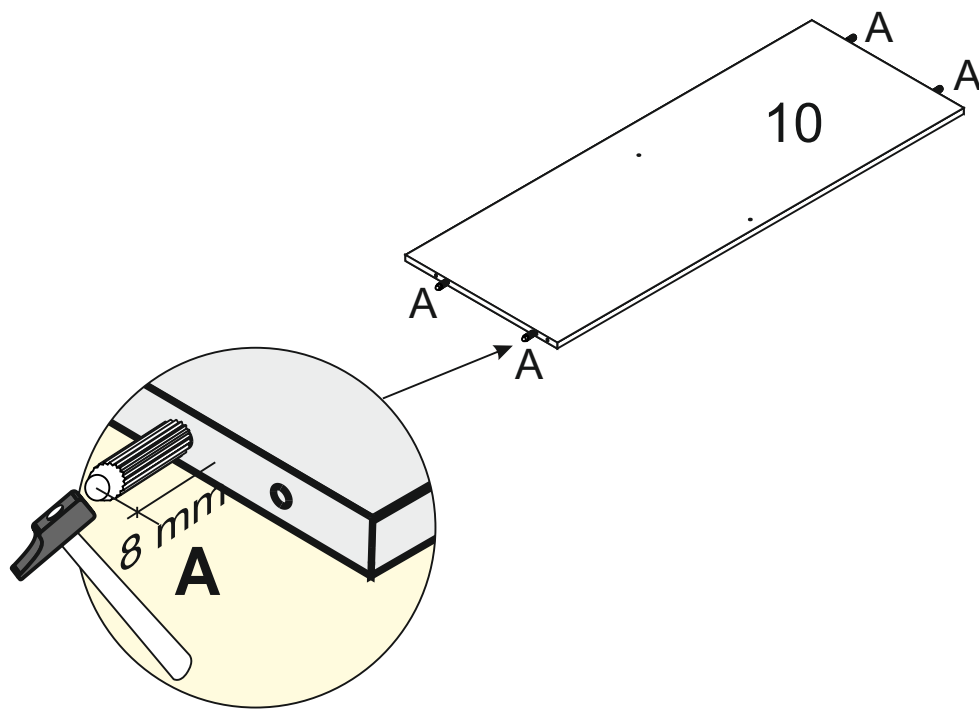

A x 4

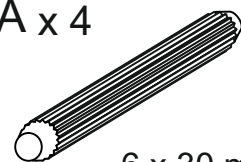

6 x 30 mm

6

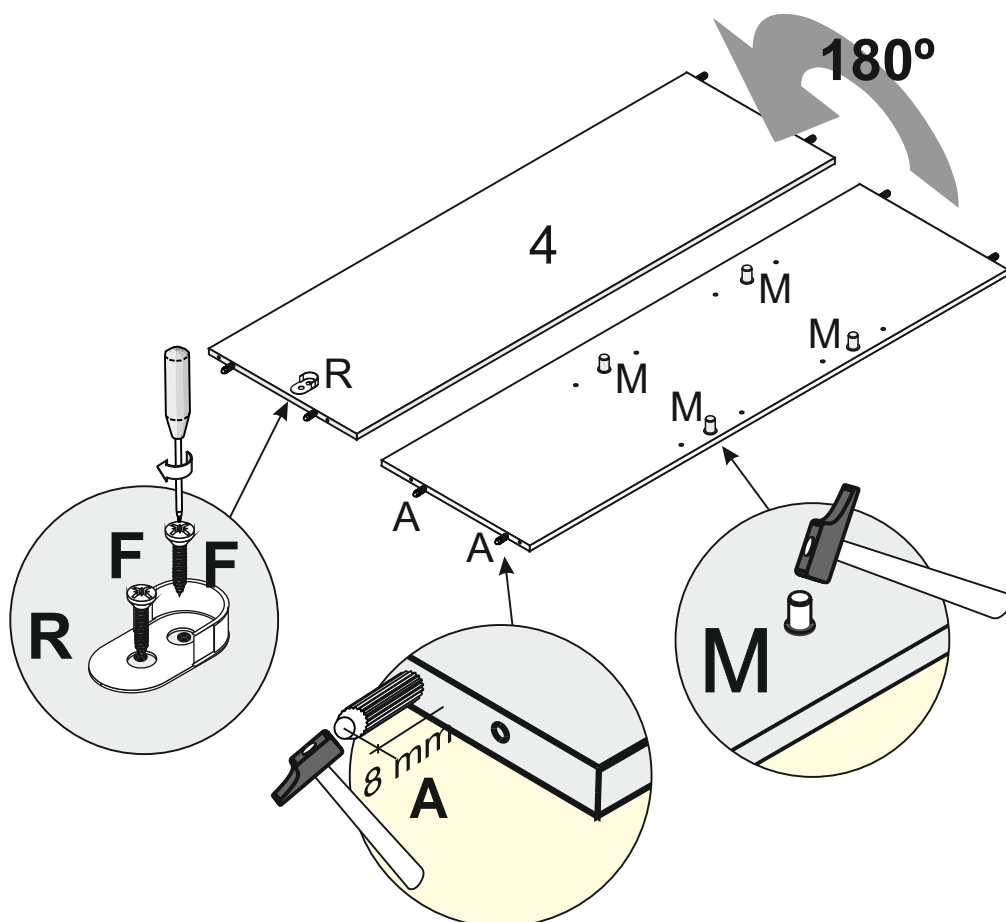

A x 4

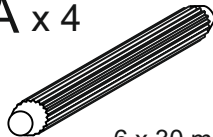

6 x 30 mm

M x 4

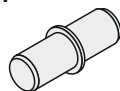

5 mm

R x 1

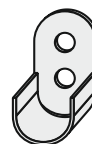

F x 2



3,5 x 16 mm

7

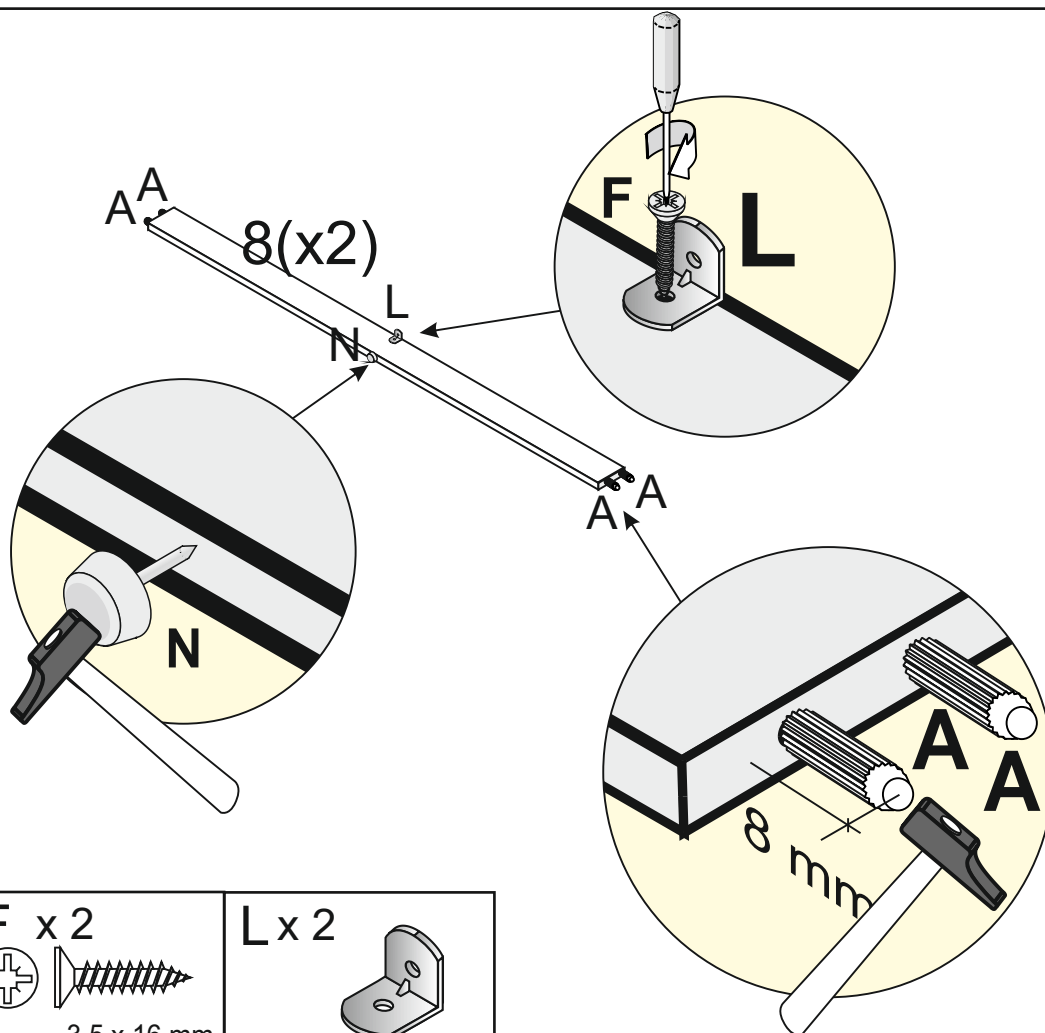

8

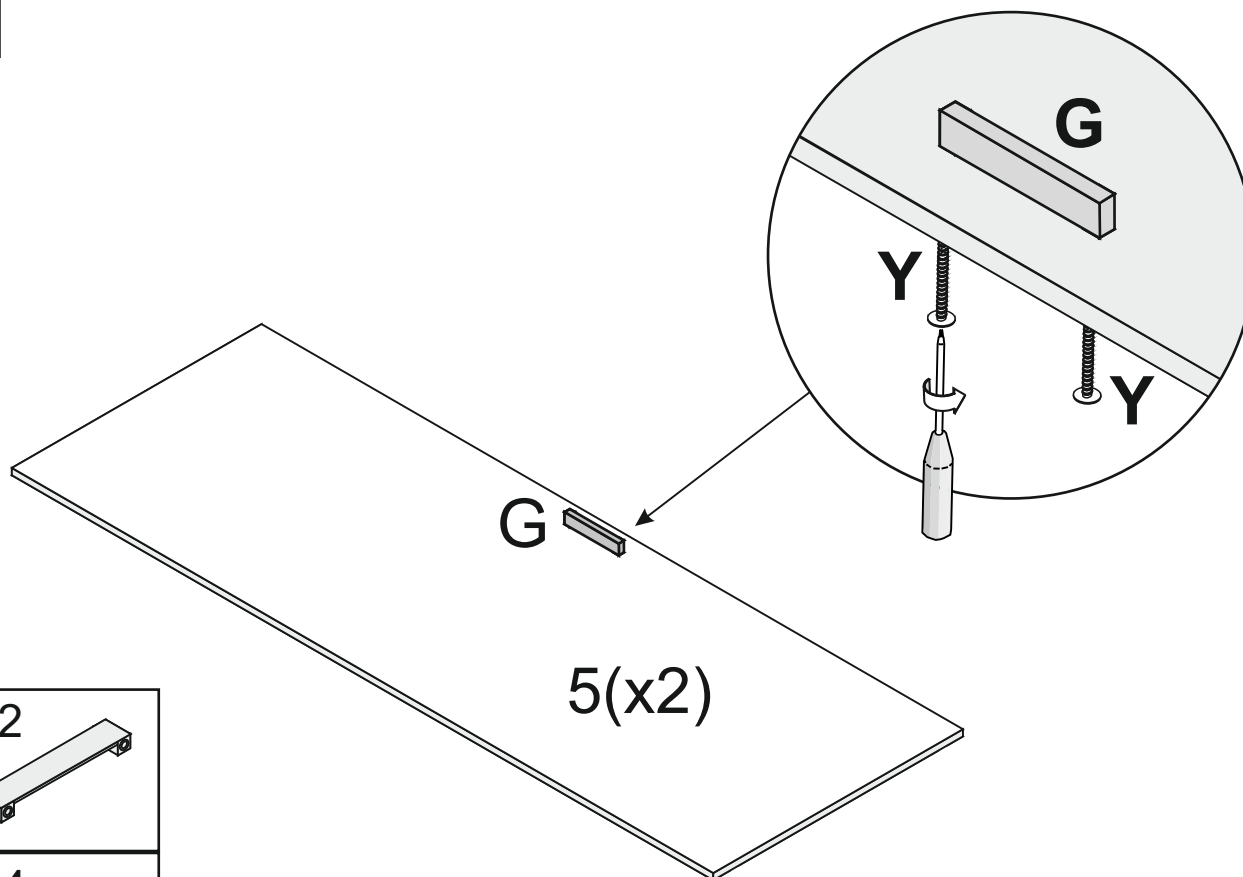



- G x 2
- Y x 4
3,5 x 27 mm

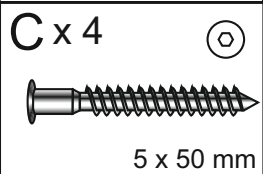
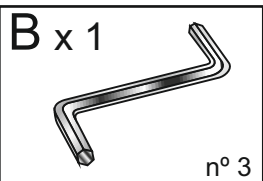
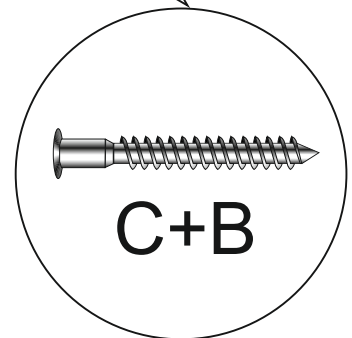
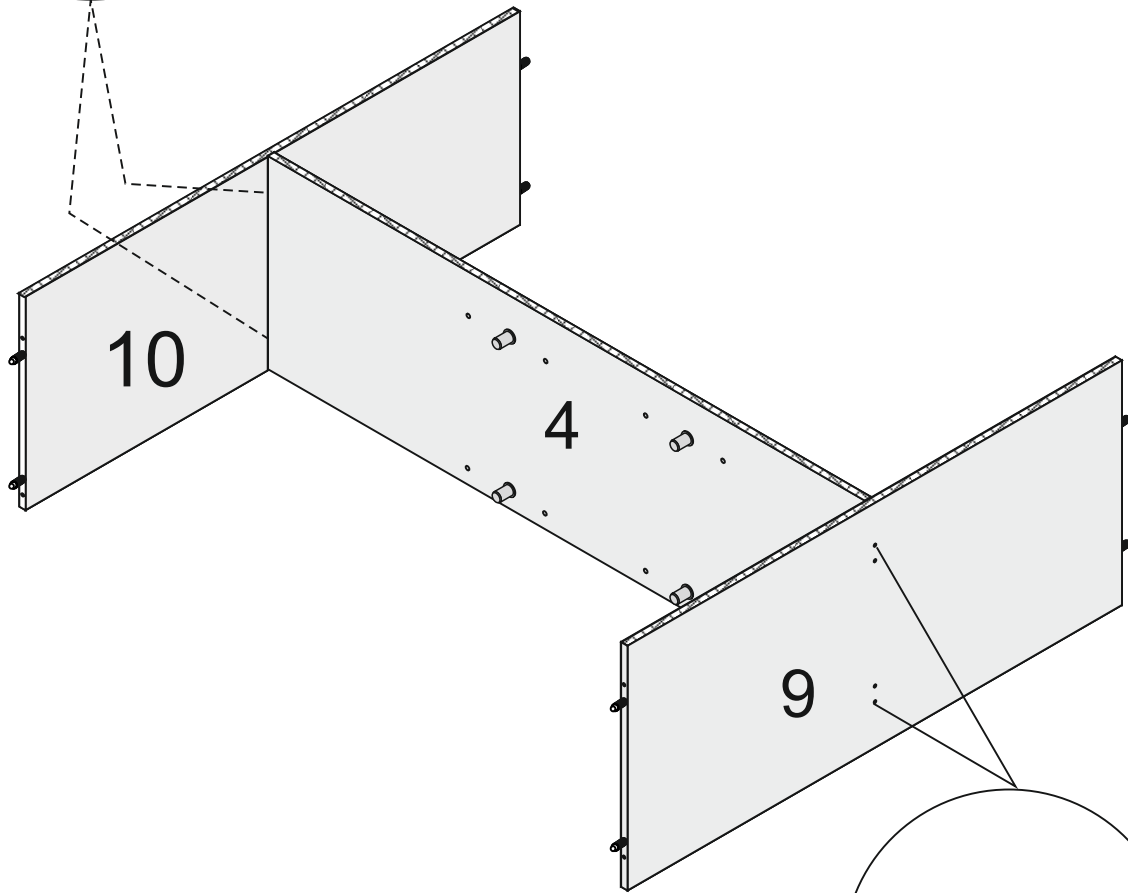
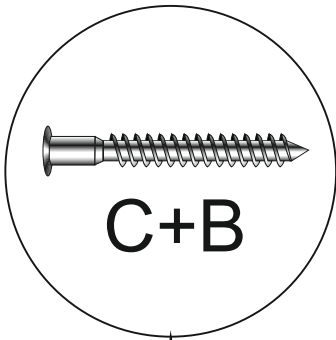

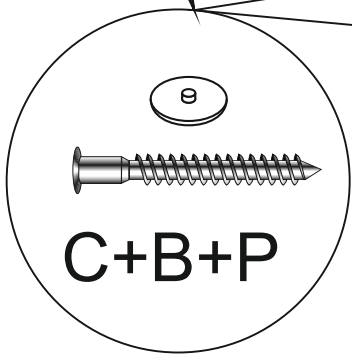
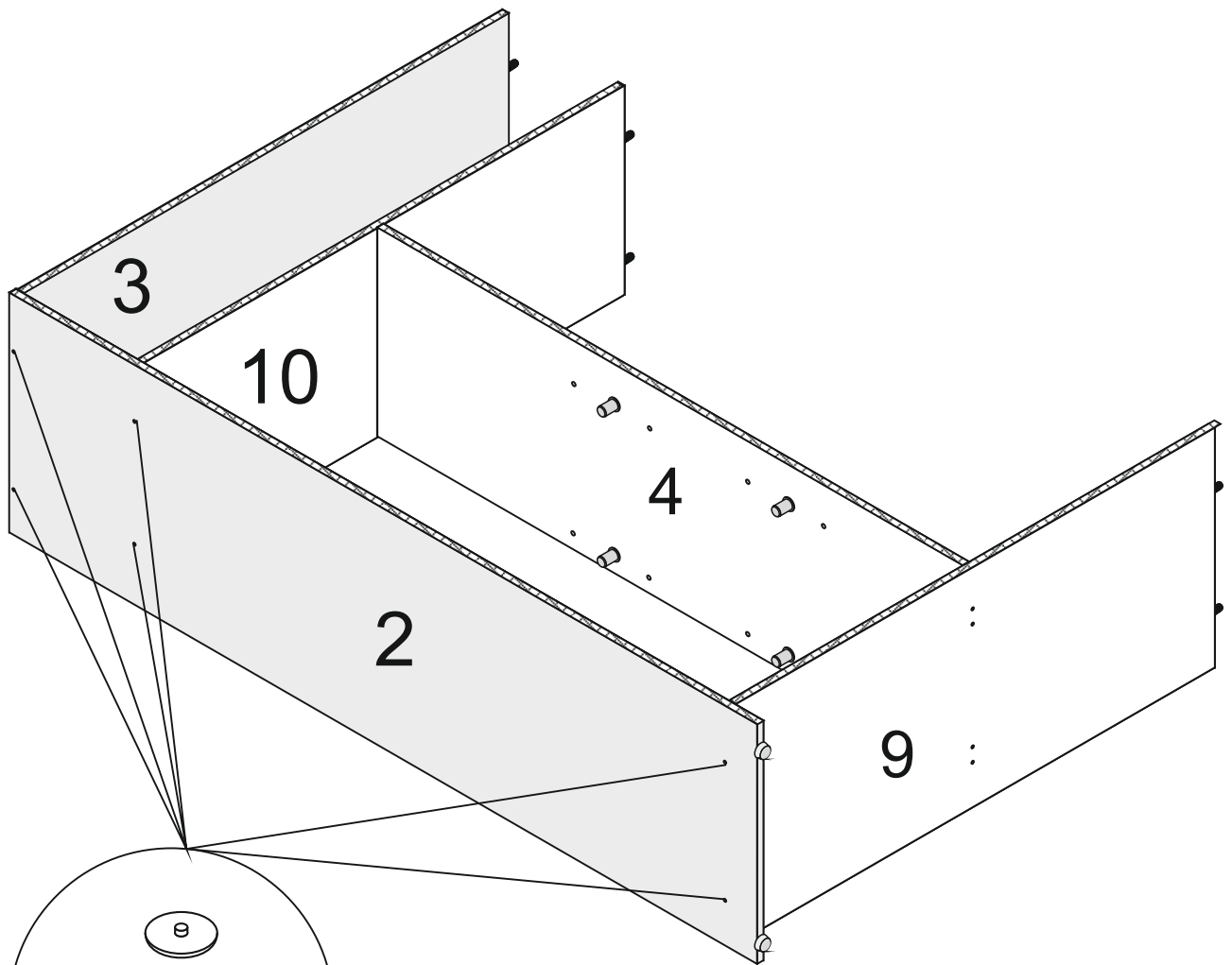

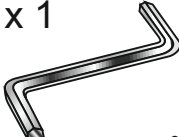
9



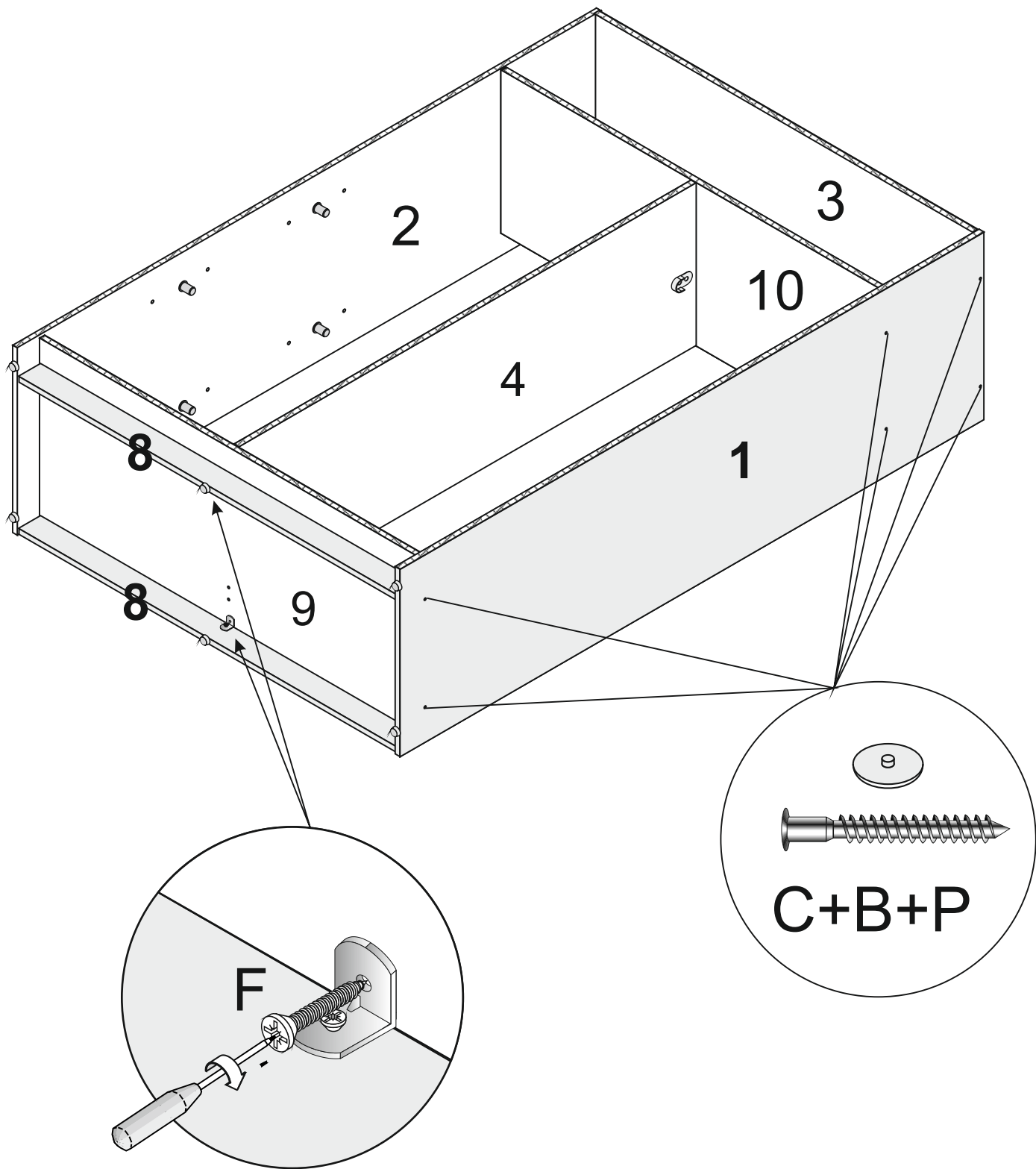

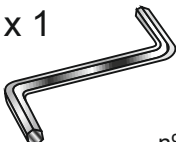

B x 1  n° 3	C x 6  5 x 50 mm	P x 6  3 mm
---	--	---

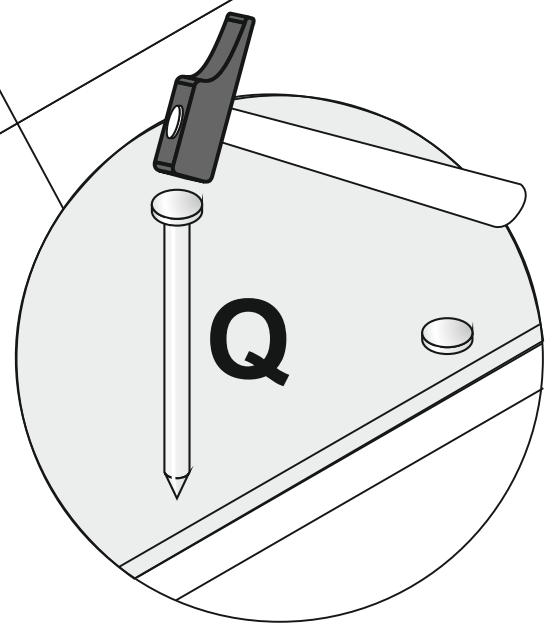
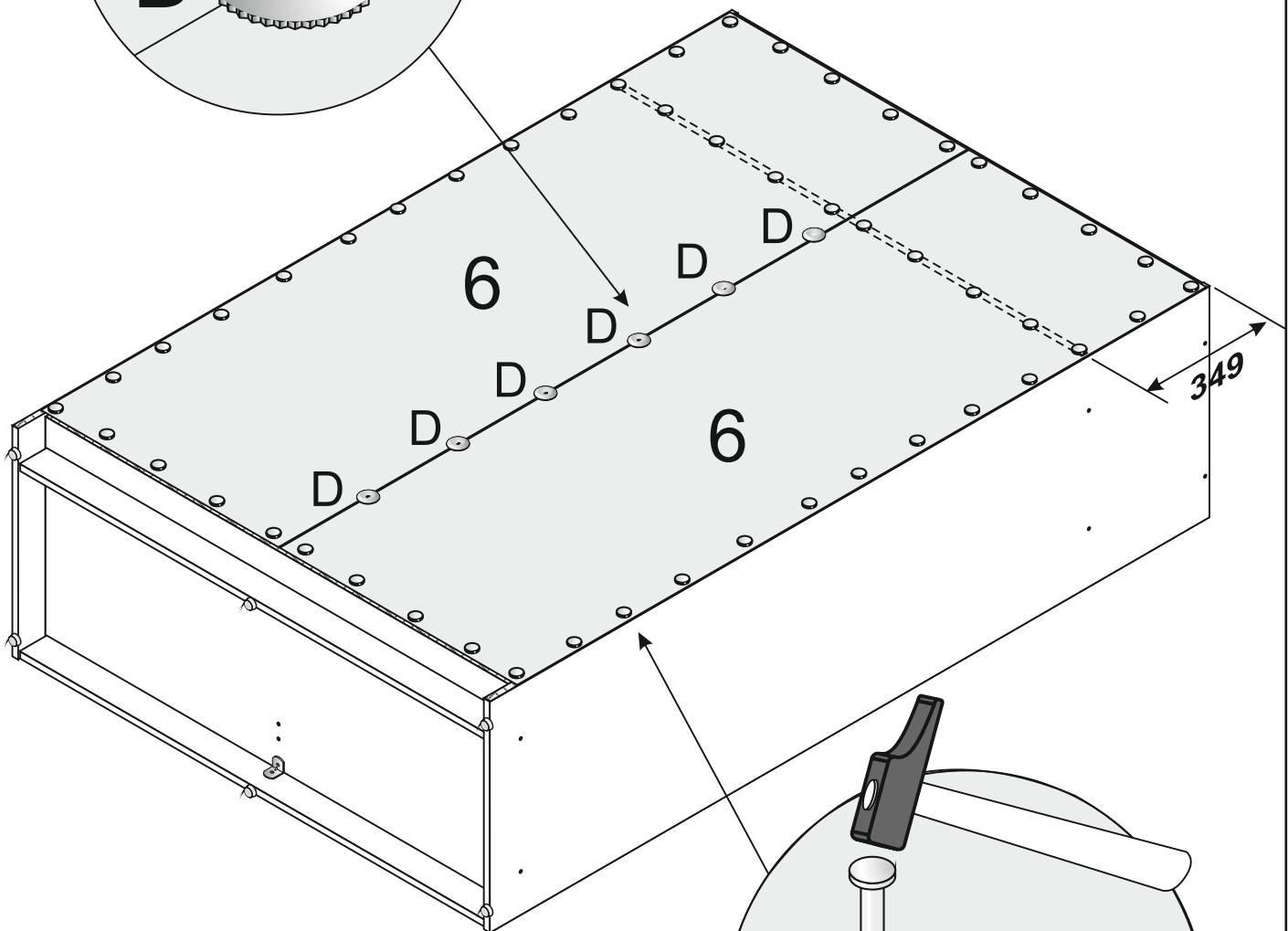
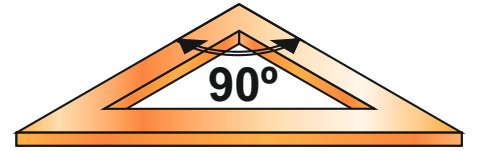
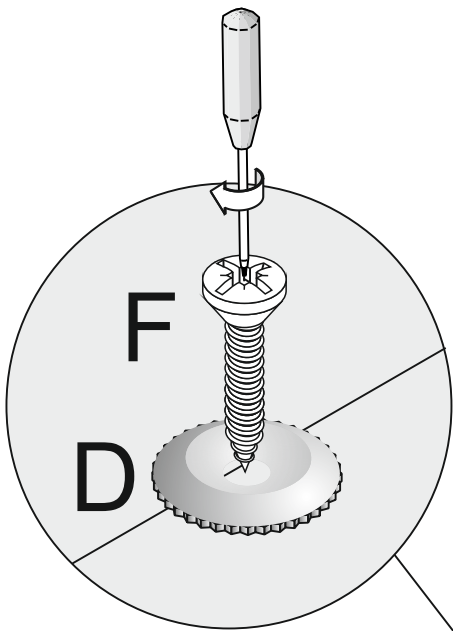

<p>B x 1</p>  <p>n° 3</p>	<p>C x 6</p>  <p>5 x 50 mm</p>	<p>P x 6</p>  <p>3 mm</p>	<p>F x 2</p>  <p>3,5 x 16 mm</p>
---	--	---	---



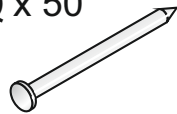

<p>D x 6</p> 	<p>F x 6</p>  <p>3,5 x 16 mm</p>	<p>Q x 50</p>  <p>20 mm</p>
--	---	--

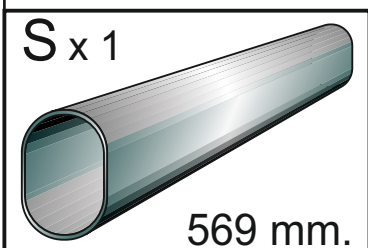
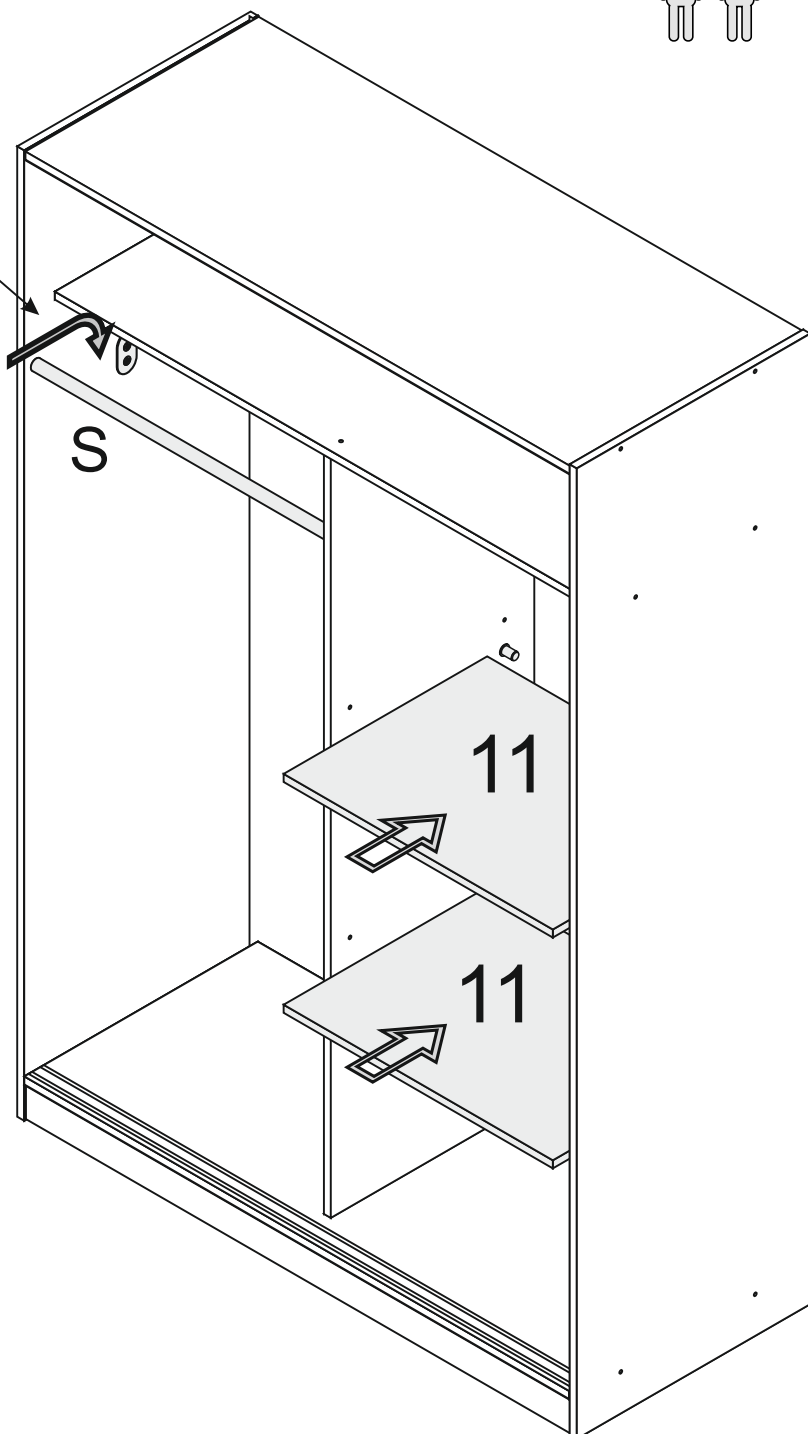
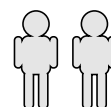
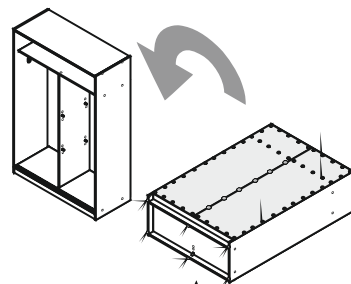
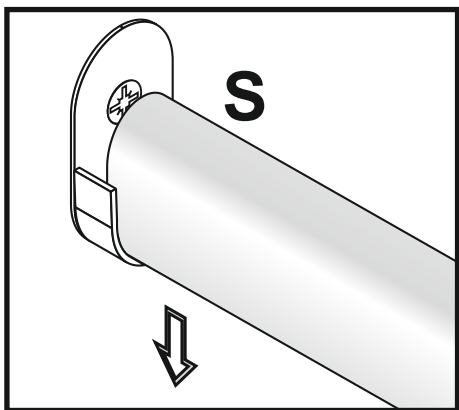
13

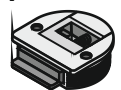

14

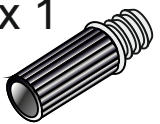
- X x 4 
- Z x 4 
- U x 8 
3 x 15 mm
- H x 1 

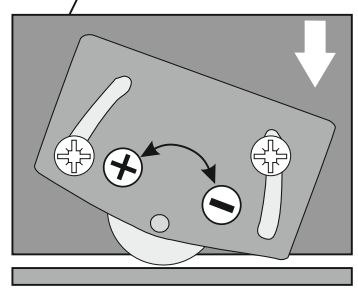
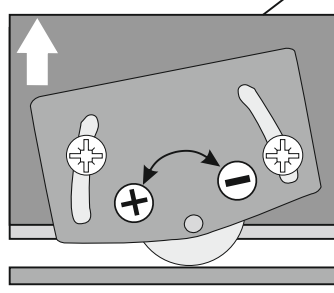
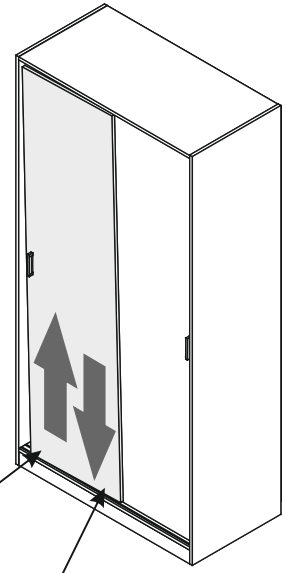
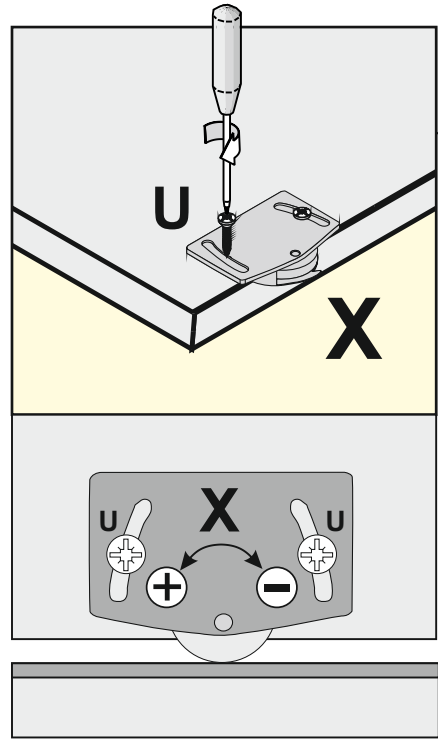
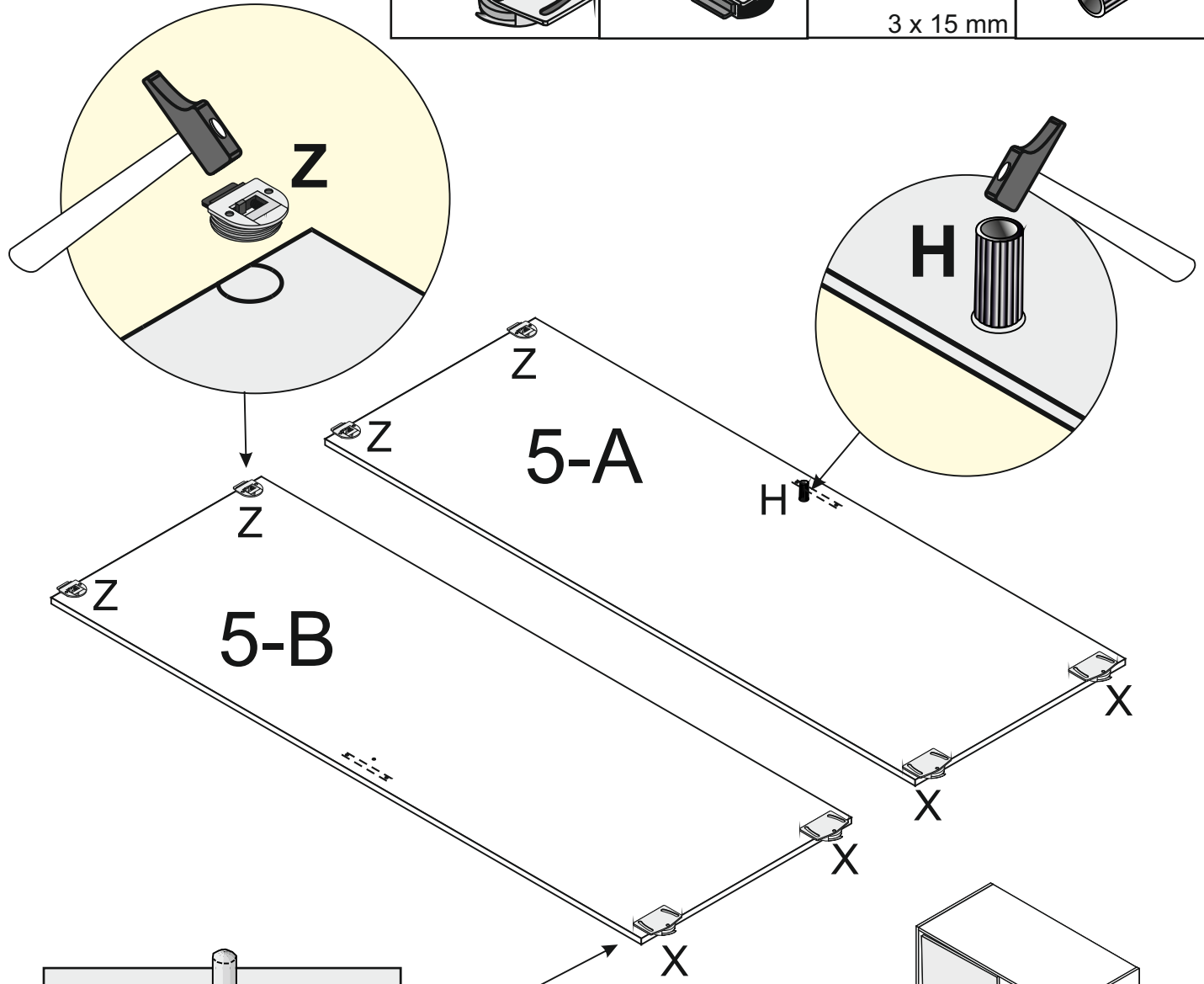

15

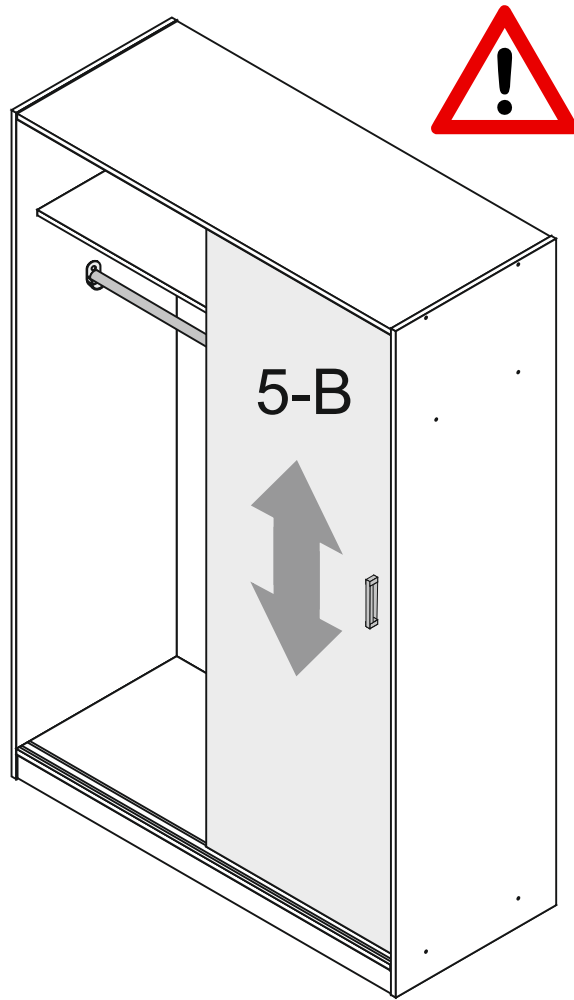
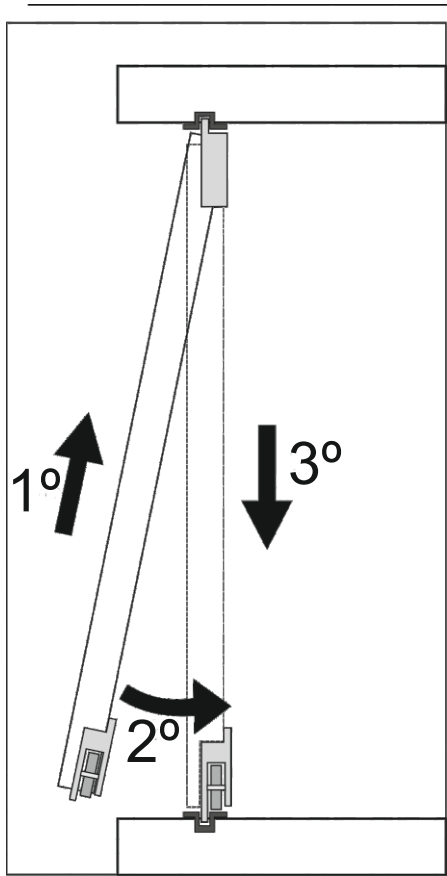

16

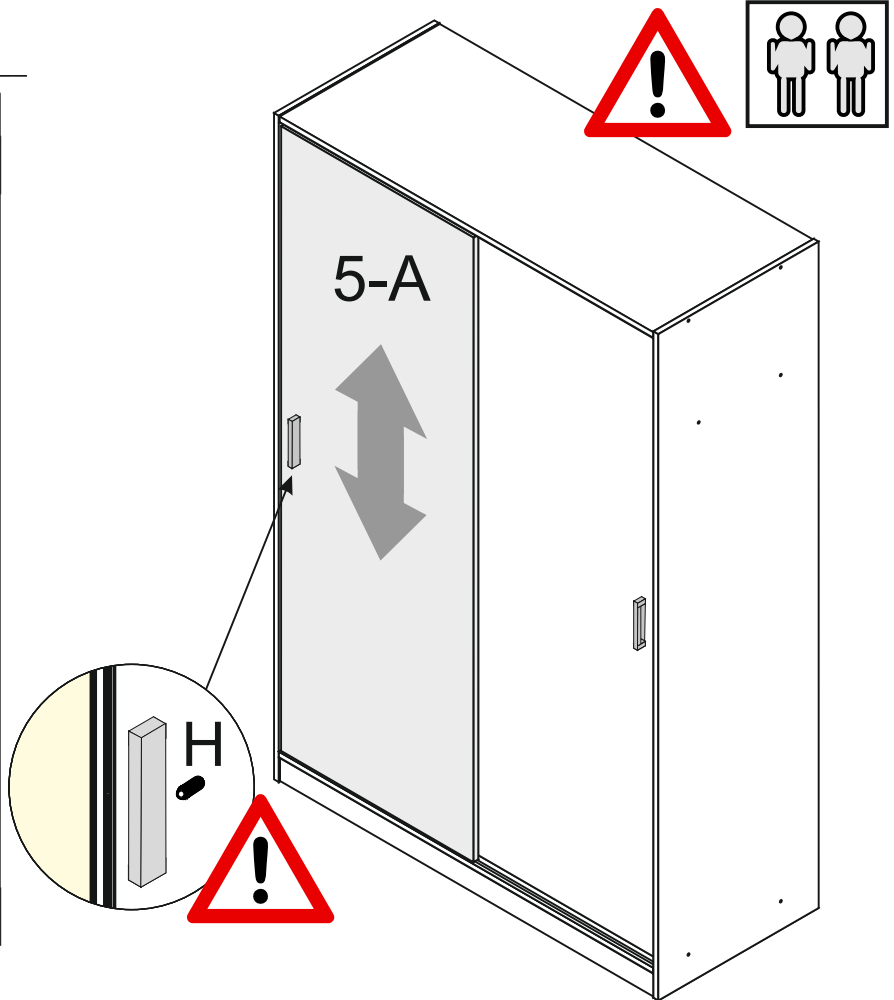
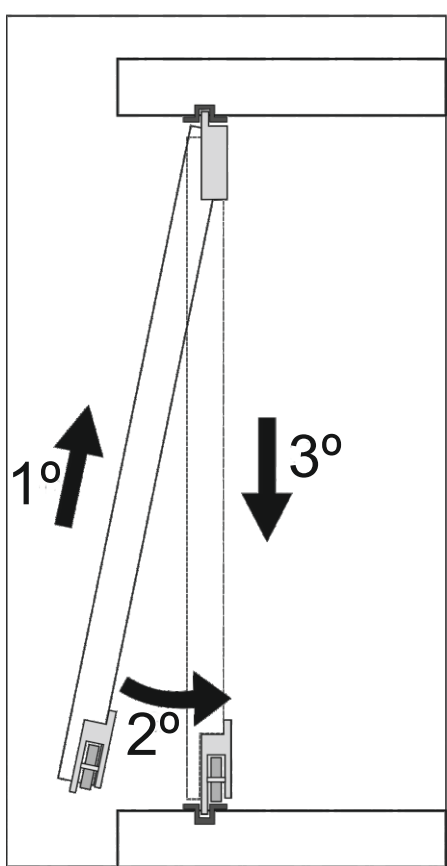

ES

RECOMENDACIONES PARA EL MONTAJE Y PARA EL USO

- Preparar las piezas que constituyen el mueble
- Reagrupar y contar el herraje
- Preparar las herramientas necesarias
- Prepara la zona de montaje
- Realizar el montaje sobre una moqueta para evitar rayar el mueble
- No forzar nunca los ensamblajes
- No colocar cerca de fuentes de calor
- No utilizar paños, trapos o productos de limpieza que puedan rayar la superficie del mueble
- Mueble apto para uso doméstico. Ubicación en el interior de la vivienda

IT

CONSEGLI PER L'INSTALLAZIONE E L'USO

- Preparate i componenti del mobile per il montaggio
- Ordinate e controllate la quantità della ferramenta
- Preparate gli attrezzi necessari
- Preparate un luogo idoneo al montaggio. Sistemate i componenti su un tappeto per non danneggiare le superfici
- Non forzate mai i componenti
- Non posizionate il mobile vicino a fonti di calore
- Non usate panni abrasivi né detergenti né solventi che possano danneggiare le superfici
- Questo prodotto è solo per uso domestico, non professionale. Non adatto per uso all'aperto

EN

RECOMENDATIONS FOR FITTING AND FOR USE

- Prepare the pieces of furniture to make it up
- Group up and count the iron parts, screws... etc.
- Prepare the necessary tools
- Prepare the fitting place
- Do the fitting on a carpet so you don't damage the furniture
- Never force the fitting
- Do not put near to any sort of heat
- Do not use cloths or cleaning products that could damage the surface of the furniture
- Furniture suitable for domestic use, keep indoors

DE

MONTAGEHINWEISE UND GEBRAUCHSHINWEISE

- Sortieren und identifizieren Sie die Einzelteile
- Überprüfen Sie die Anzahl der einzelnen Beschlagteile
- Legen Sie das notwendige Werkzeug bereit
- Einen montagebereich freimachen
- Montieren Sie das Möbel auf einem ebenen, weichen, sauberen Untergrund
- Niemals die Verbindungen zu stark anziehen
- Nicht neben Wärmequellen platzieren.
- Für die Reinigung verwenden Sie bitte ein weiches Tuch und keinesfalls scharfe oder ätzende Reinigungsmittel.
- Das Möbel ist ausschließlich für den Gebrauch im Haus geeignet.

FR

CONSEILS DE MONTAGE ET POUR L'USAGE

- Identifier les différents panneaux
- Regrouper et compter la quincaillerie
- Munissez-vous de l'outillage nécessaire
- Amenagez-vous une zone de montage. La moquette ou une couverture protégera des rayures
- Ne jamais forcer le montage
- Ne pas placer près des sources de chaleur
- N'utiliser pas de chiffons ou des produits de nettoyage qui puissent rayer la superficie du meuble
- Meuble apte pour l'usage domestique, on peut le placer à l'intérieur de la maison

HR

PREPORUKE ZA MONTAŽU I ZA UPORABU

- Pripremite komada namještaja za montiranje
- Pripremite sve dijelove namještaja.
- Pripremite potrebne alat
- Pripremite prostor za montažu
- Učinite montažu na tepihu, tako da ne oštetiti namještaj
- Nemojte upotrebljavati silu prilikom sklapanja
- Ne stavljajte blizu bilo kakve topline
- Ne koristite krpe ili proizvode za čišćenje koji bi mogli oštetiti površinu namještaja
- Namještaj prikladni za kućnu uporabu.
- Položaj unutar kućišta

PT

AVISO PARA MONTAGEM E PARA USO

- Preparar as peças que compõem o móvel
- Reagrupar e contar as ferragens
- Preparar as ferramentas necessárias
- Prepara o local para a montagem
- Efectuar a montagem sobre uma alcatifa para evitar arranhar o móvel
- Nao forar nunca a ensambladura
- Nao colocar perto de fontes de calor
- Nao utilizar panos, trapos ou produtos de limpeza que possam riscar a superficie do móvel
- Móvel apto para o uso doméstico. Colocação no interior da vivenda

GR

ΣΥΜΒΟΥΛΕΣ ΣΥΝΑΡΜΟΛΟΓΗΣΗΣ ΚΑΙ ΧΡΗΣΗΣ

- Προετοιμάστε τα μέρη του επίπλου
- Ομαδοποιήστε και μετρήστε τα μικρά μέρη (βίδες, μεντεσέδες...)
- Προετοιμάστε τα εργαλεία που θα χρειαστείτε
- Προετοιμάστε το χώρο συναρμολόγησης
- Μια μοκέτα θα προφύλασσει από γρατζουνιές
- Μη ασκείτε πίεση στην εφαρμογή
- Μη τοποθετείτε κοντά σε πηγή θερμότητας
- Μη χρησιμοποιείτε πανιά και καθαριστικά που μπορούν να καταστρέψουν την επιφάνεια
- Το έπιπλο έχει κατασκευαστεί για οικιακή χρήση, τοποθετήστε το στο εσωτερικό της οικίας

GARANTÍA - GUARANTEE - GARANTIE - GARANTIA - GARANZIA - GARANTIE - JAMČITI - GARANTISI

ES Fabricado en U.E. por FORES DISEÑO S.L. C.I.F: B-12313003 - Ctra.Nac.232; Km 11,1 C.P. 12320 - Sant Jordi (Castellón) SPAIN - el cual garantiza este producto por un periodo de **2 años** a partir de la fecha de compra, contra todo defecto de fabricación.

Si se encuentra alguna dificultad a la hora del montaje o existe algún defecto en el mueble, puede contactar con nosotros al **964 46 52 22** o por e-mail: **postventa@fores.es** donde gustosamente atenderemos todas sus consultas. HORARIO: de lunes a viernes de 9h a 14h y de 15h a 18h.

Esta garantía no ampara los defectos producidos por un mal montaje, utilización indebida o mal uso del mueble.

Es imprescindible conservar el **ticket** de compra y facilitar el **Nº de Control de Calidad** para cualquier consulta o reclamación.

EN Manufactured in Spain by FORES DISEÑO S.L. CIF B-12313003-ctra Nac 232 km 11.1 C.P.12320-Sant Jordi, (Castellón) SPAIN - Guarantee of **2 years** from date of purchase against any fault of production.

If a difficulty when assembly or a fault in the product is found you can contact us at **(+34) 964 46 52 22** or by email: **postventa@fores.es** where we will be pleased to help you. TIMETABLE: Monday until Friday 9-14h / 15-18h.

The Guarantee does not cover the faults produced by an incorrect assembly or misuse of the furniture.

Indispensable to keep the purchase **ticket** and facilitate the **Nº of Quality Control** for any consult or claim.

FR Fabriqué en UE par FORES DISEÑO S.L. CIF B-12313003 - Ctra Nac 232; Km 11,1 CP12320 - Sant Jordi (Castellón) Espagne - Celui ci garantie ce produit pour une période de **2 ans** à partir de la date d'achat, contre tout défaut de fabrication.

Si vous rencontrez une quelconque difficulté à l'heure du montage ou si il y a un défaut sur le meuble, vous pouvez nous contacter par téléphone au **(+34) 964 46 52 22** ou bien par e-mail à **postventa@fores.es** où nous aurons le plaisir de vous accueillir pour toutes demandes. Nos HORAIRES sont du lundi au vendredi de 9H00 à 14H00 et de 15H00 à 18H00.

Cette garantie ne couvre pas les défauts résultants d'un mauvais montage, d'une utilisation indue ou d'un mauvais usage du produit.

Il est indispensable de garder le **ticket** ou facture d'achat et de communiquer **le Numéro de Control Qualité** pour une quelconque demande ou réclamation.

PT Fabricado U.E. por FORES DISEÑO S.L. C.I.F: B-12313003 - Ctra.Nac.232; 11,1 km C.P. 12320 - Sant Jordi (Castellón) ESPANHA - que garante este produto por um período de **2 anos** a partir da data de compra; contra defeitos de fabricação.

Se você encontrar qualquer dificuldade na montagem ou se houver qualquer defeito no armário, você pode contactar-nos pelos seguintes meios: **(+34) 964 46 52 22** ou por e-mail: **postventa@fores.es** onde será recebido de bom grado para atenderder-mos todas as suas dúvidas. HORÁRIOS: Segunda a sexta-feira das 9h às 14h e 15h às 18h.

Esta garantia não cobre defeitos causados pela montagem incorreta, uso indevido ou mau trato do produto.

É essencial manter o **recibo** de compra e facilitar o **Nº Controle de Qualidade** para quaisquer dúvidas ou reclamações.

IT Prodotto in Spagna da: FORES DISEÑO S.L. CIF B-12313003-ctra Nac 232 km 11.1 C.P.12320-Sant Jordi, (Castellón) SPAIN. Garantito **2 Anni** dalla data di acquisto contro ogni difetto di produzione.

In caso di difficoltà nel montaggio o di mancanza di componenti potete chiamare il **(+34) 964 46 52 22** o inviare email a: **postventa@fores.es** Il servizio è attivo dal Lunedì al Venerdì ore 9:00-14:00 / 15:00-18:00 Saremo lieti di aiutarvi.

La garanzia non copre difetti o danni dovuti a montaggio scorretto o ad uso improprio del prodotto.

La garanzia è valida solo in presenza dello **scontrino di acquisto** e sarà più tempestiva se conservate il **nº di controllo qualità** presente nella confezione.

DE Hergestellt in Spanien von FORES DISEÑO S.L. CIF B-12313003-ctra Nac 232 km 11.1 CP12320-Sant Jordi (Castellón) SPANIEN - Garantie von **2 Jahren** ab kaufdatum gegen jede störung der produktion.

Wenn Sie irgendwelche schwierigkeiten bei der montage zu finden oder es irgendeinen defekt in dem schrank, können sie uns unter **(+34) 964 46 52 22** oder per email an: **postventa@fores.es**, wo wir gerne besuchen, um alle Ihre Fragen. ÖFFNUNGSZEITEN: Montag bis Freitag von 9h bis 14h und 15h bis 18h.

Diese Garantie gilt nicht für Mängel, die durch unsachgemäße Installation, unsachgemäße Behandlung und Verwendung des Geräts verursacht werden.

Unentbehrlich, um den **Kauf Ticket** behalten und erleichtern die Anzahl der **Qualitätskontrollzahl** für alle zu konsultieren oder Anspruch.

HR Proizvedeno u Španjolskoj od strane FORES DISEÑO S.L. cif B-12313003-CTRA Nac 232 km 11,1 CP12320-Sant Jordi, (Castellón) Španjolska - jamstvo **2 godine** od datuma kupnje protiv krivnjom proizvodnje.

Ako poteškoća kada se utvrdi Skupština ili greška u proizvodnju možete nas kontaktirati na **(+34) 964 46 52 22** ili putem e-maila: **postventa@fores.es** gdje ćemo biti drago da vam pomogne. RASPORED: ponedjeljak do petka 9-14h / 15-18h.

Jamstvo ne pokriva kvarove produkciji pogrešne montaže ili zlouporabe namještaja

Neophodan zadržati kupnju **ulaznica** i olakšati **Nº kontrole kvalitete** za bilo konzultirati ili zahtjev.

GR Κατασκευάζεται στην Ισπανία από CIF B-12313003-Ctra Nac 232 χλμ 11.1 CP12320-Sant Jordi, στην Ισπανία - Η εγγύηση ισχύει για **2 έτη** από την αρχική ημερομηνία αγοράς και καλύπτει ελαττωματικά υλικά ή ελαττωματική κατασκευή του προϊόντος.

Σε περίπτωση δυσκολίας σας κατά την συναρμολόγηση ή πιθανής βλάβης στο προϊόν, μπορείτε να επικοινωνήσετε μαζί μας στο **(+34) 964 46 52 22** ή μέσω email: **postventa@fores.es** Θα χαρούμε να σας βοηθήσουμε. ΗΜΕΡΕΣ & ΩΡΕΣ ΕΞΥΠΗΡΕΤΗΣΗΣ: Δευτέρα έως Παρασκευή 9:00-14:00 & 15:00-18:00.

Η εγγύηση δεν καλύπτει τις βλάβες που προέρχονται από λάθη στην συναρμολόγηση ή την μη ορθολογική χρήση των επίπλων.

Είναι απαραίτητο να κρατήσετε την **απόδειξη αγοράς** του προϊόντος και τον **αριθμό ποιοτικού ελέγχου**, ώστε να διευκολύνετε οποιαδήποτε διαδικασία αίτησης ή συμβουλής χρειαστείτε.

Nº de Control de Calidad:

Nº of Quality Control:

Nº de Contrôle Qualité:

Nº de Controle de Qualidade:

Nº di Controllo qualità:

Qualitätskontrollzahl:

Nº kontrole kvalitete:

Ποιοτικός έλεγχος Αριθμός:

00000.17



ARMARIO - WARDROBE - ARMOIRE - ROUPEIRO -
GUARDAROVA - KLEIDERSCHRANK - ORMAR - ΝΤΟΥΛΑΠΑ

