

Монтажна схема Installation manual

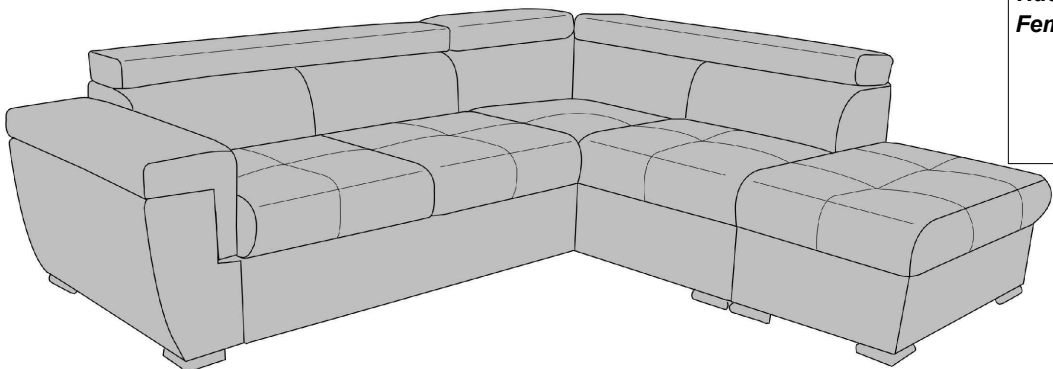

Крак - 10 бр.
Legs - 10 pcs.

A

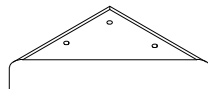

Крак - 4 бр.
Legs - 4 pcs.

B



Винт 5x35 - 34 бр.
Screw - 5x35 - 34pcs.

C



Винт 3.5x20 - 20 бр.
Screw - 3.5x20 - 20pcs.

D



Нарещник - 2 бр.
Female joint - 2 pcs.

E

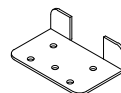

Планка - 2 бр.
Male joint - 2 pcs.

F

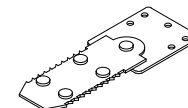

Болт - 6x35 - 4 бр.
Bolt - 6x35 - 4 pcs.

G

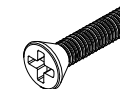

Колело - 2 бр.
Wheel - 2 pcs.

H

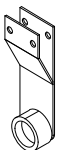

h-85

Гайка M6 - 4 бр.
Nut M6 - 4 pcs.

I

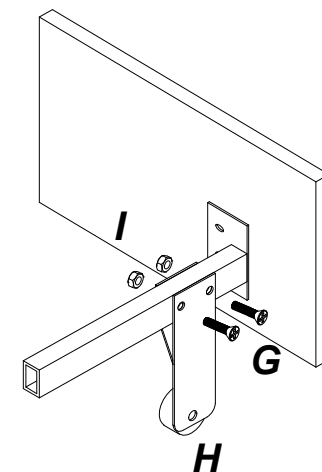
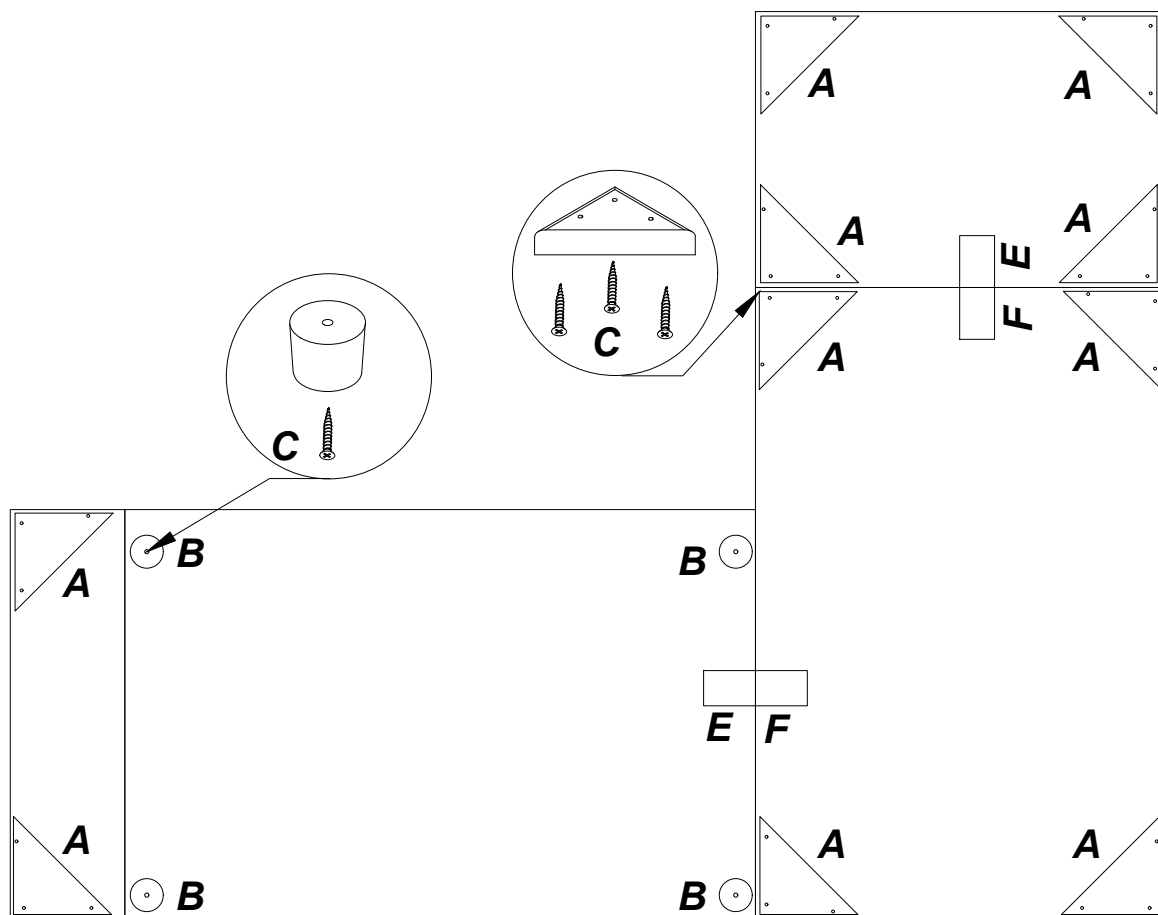

Внимание! За да се избегне нараняване, са необходими двама души.

Attention! In order to prevent any damages, it is recommended two people to participate in the assembling of the sofa.